

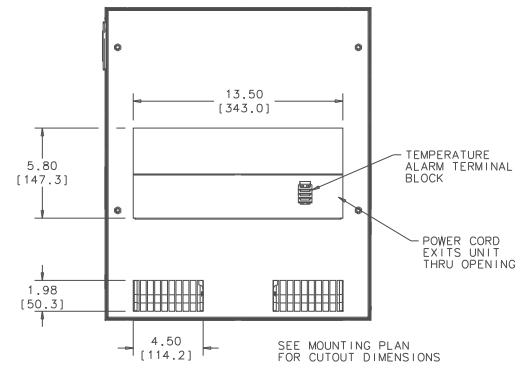

THIS DOCUMENT IS THE PROPERTY OF KOOLTRONIC, INC. AND CONTAINS PROPRIETARY AND CONFIDENTIAL INFORMATION WHICH MUST NOT BE DUPLICATED, USED OR DISCLOSED TO OTHERS, EXCEPT AS EXPRESSLY AUTHORIZED IN WRITING BY KOOLTRONIC, INC.

REVISONS		DESCRIPTION	DATE	APPROVED
5/M	NOTICE			
-	EC 17/065	NEW DRAWING RELEASE	2/21/17	J5/SDS

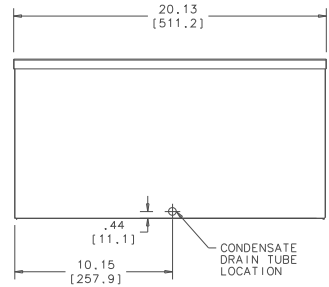
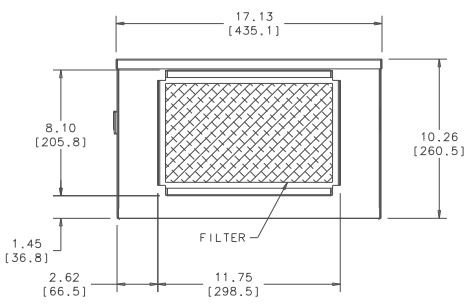
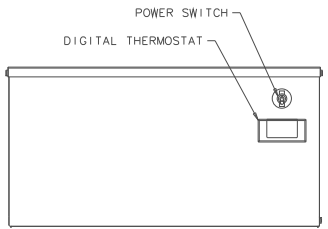
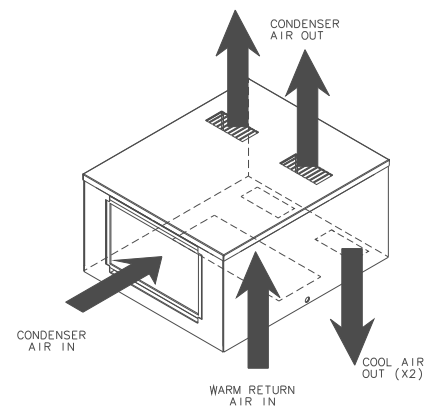
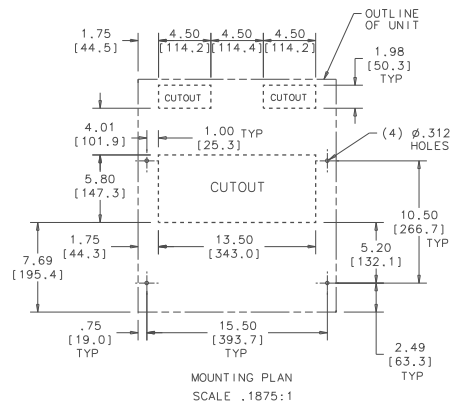
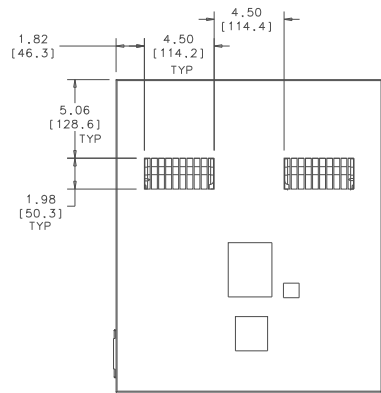

ALL DIMENSIONS ARE IN INCHES. DIMENSIONS DESIGNATED MM ARE IN MILLIMETERS. UNLESS OTHERWISE SPECIFIED TOLERANCES NON-DECIMALATIVE.				DRAWN BY: JERRY STEDNICK DATE: 2/21/17		 <small>PENNSYLVANIA, PA USA</small>
TOL. ON	INCHES	MM	CHECKED	DATE		
.XX	: .02	:	Steve Schmierer	2/21/17		
.XXX	: .010	:	Sepehr Sabeti	3/10/17		
ANGULAR	: 1/2		MFG. ENG.			
MATERIAL						
UNIT	K_A4C4HTL	APPROVED	Joe Milko	8/22/17		
CODE IDENT. NO.	06223	SIZE	D	DWG. NO.	GAB009A	
SCALE	25-1	CAD. REF.				
					REV	-
					SHEET	1 OF 1